

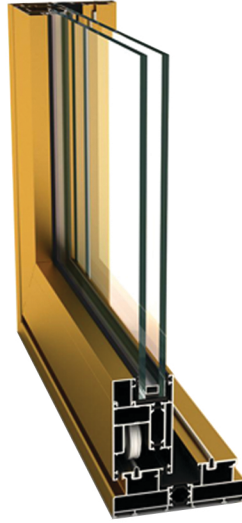

YENİ SİSTEMLER KATOLOĐU



AHS 125 KALDIR SÜR SERİSİ



Kaliteyi takip etmiyor kaliteye yön veriyoruz.

Kalite bizim için vazgeçilmezdir.



Türk alüminyum sanayinin en güçlü firmalarından biri olan AKPA Alüminyum, Euro normlarına uygun olarak ürettiği her üründe teklif aşamasından ürünün teslimatına kadar Kalite Yönetim Sistemi uyguluyor.

AKPA Alüminyum TSE 755-1, TSE 5247 en 12020-01, TSE 4922, ISO 9001:2000 CE belgelerinin yanında QUALICOAT ve IFT ROSENHEIM kalite sertifikalarına sahip olarak tüm ürünlerinde yüksek kalite standartlarını belgelendirmiştir.

Tüm üretim süreçlerinde yüksek kalitenin önemini bilen içinde uzman 550 eğitilmiş ve deneyimli personeli ile 80000 metrekarelik tesislerinde;

Yıllık 1400 adet kalıp üretimi

Aylık 4 pres hattı ile toplamda 2000 ton profil üretimi

Aylık 1000 ton eloksallı üretim

Aylık 1200 ton Elektrostatik üretim

Aylık 100 ton ahşap kaplama film üretimi kapasitesine sahiptir.





AKPA Alüminyum yatırımlarına hız kesmeden devam ediyor.



1986 yılından beri Türk alüminyum sektörünün güçlü oyuncularından biri olarak varlığını devam ettiren AKPA Alüminyum, dökümhane, kalıp üretim hattı, ekstrüzyon tesisi, boya hattı, eloksal hattı, mekanik arıtma ve yükleme departmanları ile entegre bir tesistir.

Kurulduğu günden bu yana sürekli büyüme misyonuyla hareket eden AKPA Alüminyum, sektörün ihtiyaçları doğrultusunda yeni yatırımlar yaparak sektördeki güçlü konumunu sürdürüyor.

Tüm üretim süreçlerinde yüksek müşteri memnuniyetini esas alan AKPA Alüminyum, modern üretim tesislerinde, inovatif ürün gamını yurt içi ve yurtdışından tüm müşterilerine güvenle sunuyor.

Yurtiçi pazarlarındaki güçlü konumunu yurtdışı pazarlarda da devam ettiren AKPA Alüminyum, kaliteli ürünlerini tüm dünyaya güvenle ulaştırıyor.



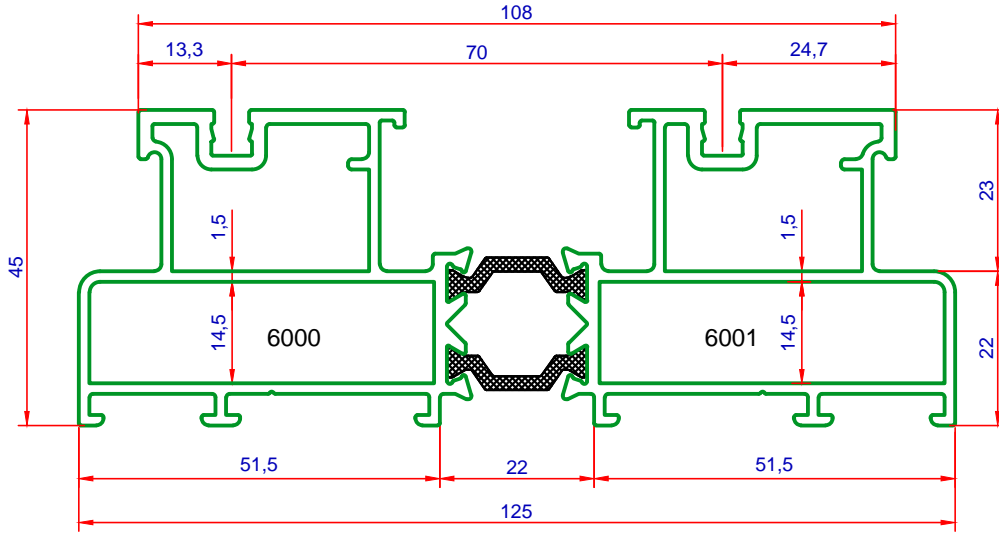

6000 - 6001
2.570 kg/m

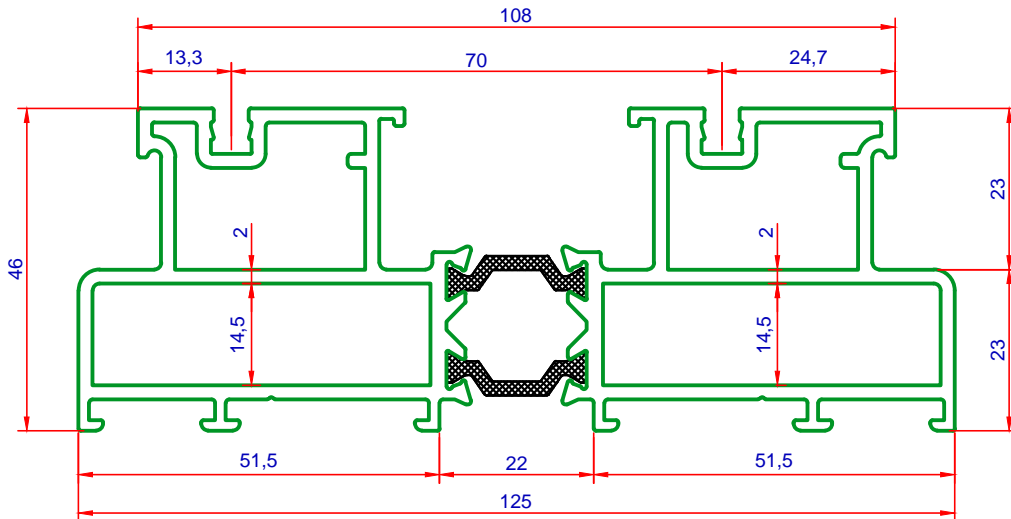

6002 - 6003
3.048 kg/m

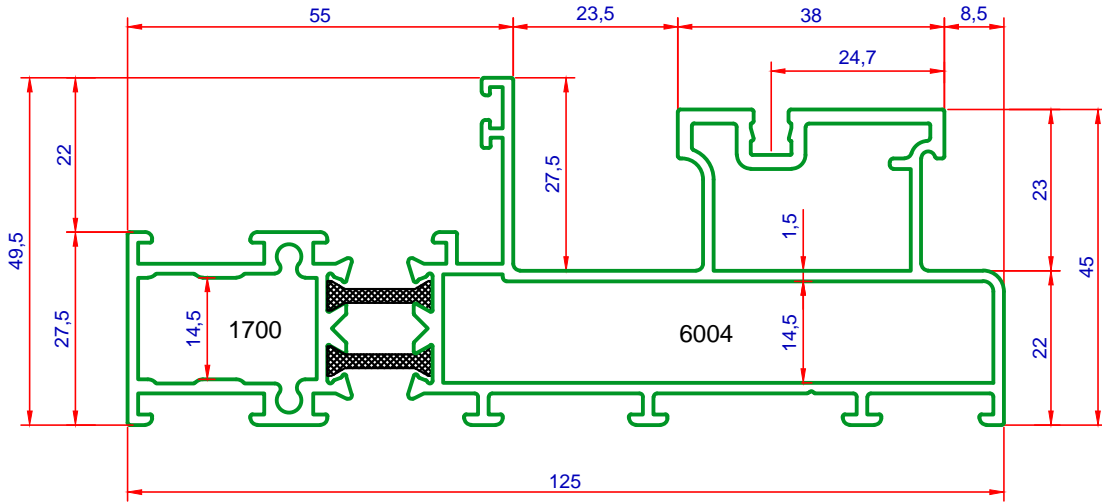

6004 - 1700

2.397 kg/m

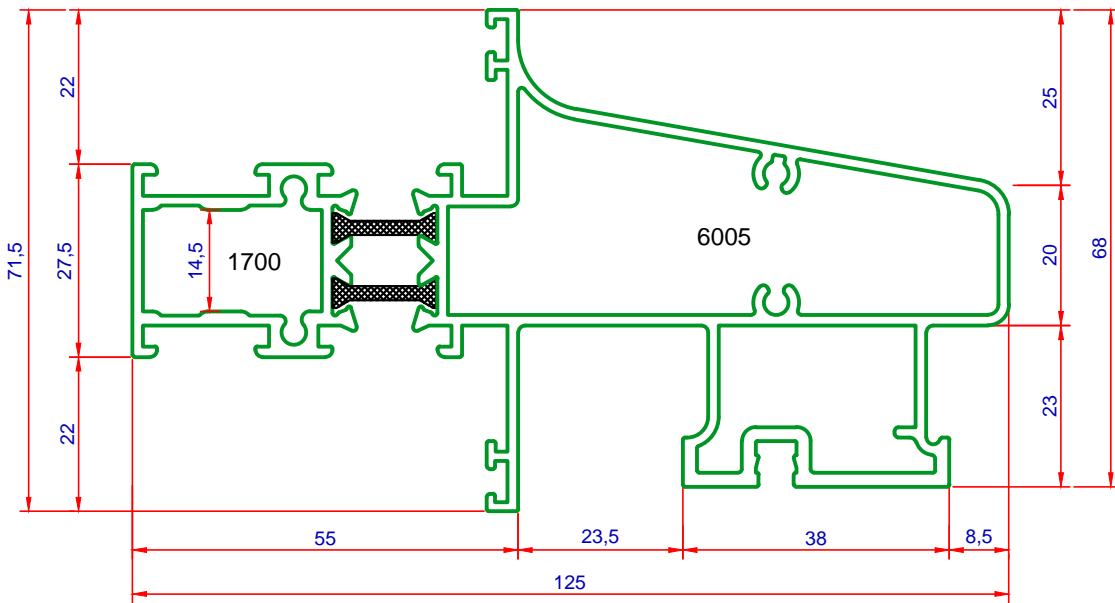

6005 - 1700

2.538 kg/m

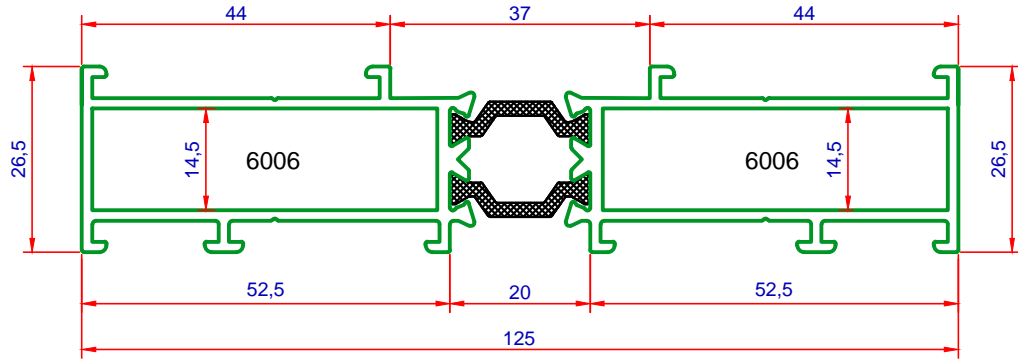

6006 - 6006
1.687 kg/m

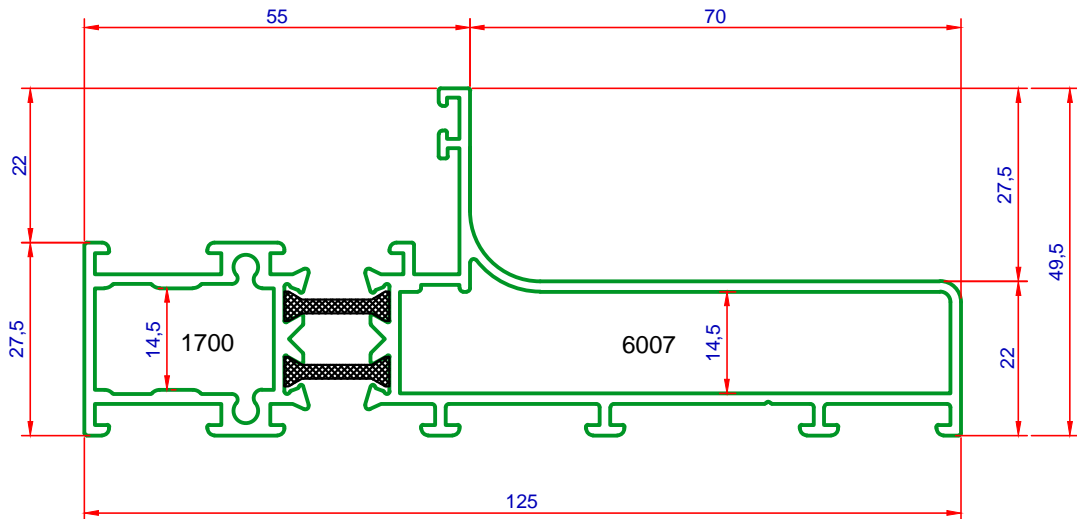

6007 - 1700
1.924 kg/m

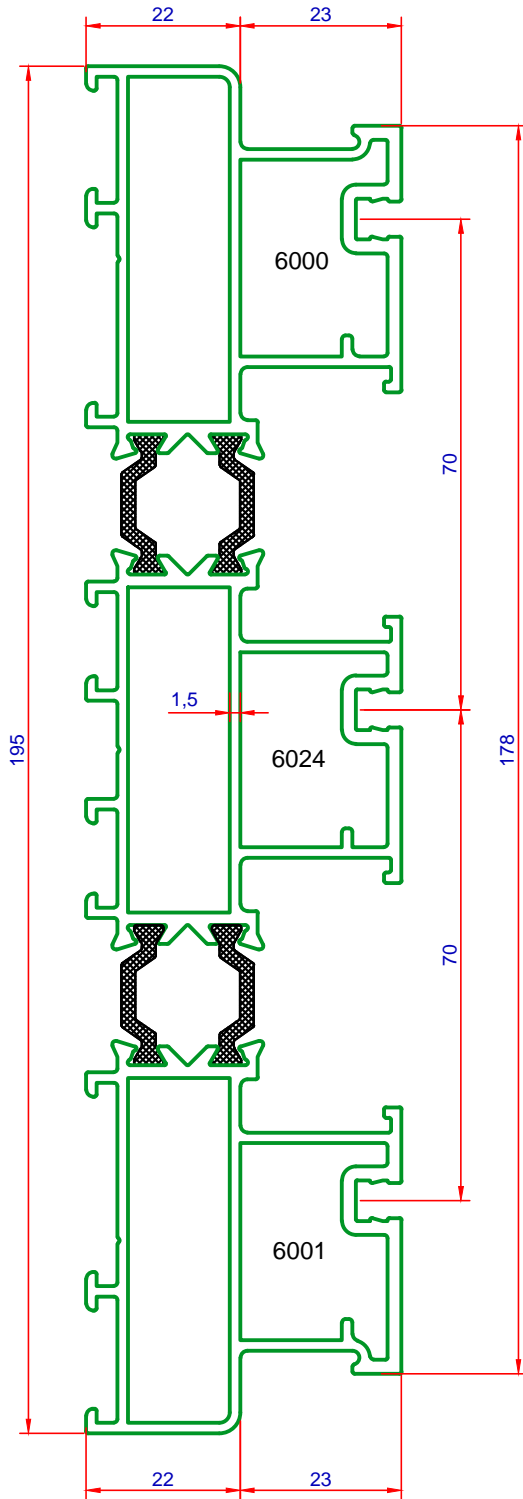

6000 - 6024 - 6001
4.018 kg/m

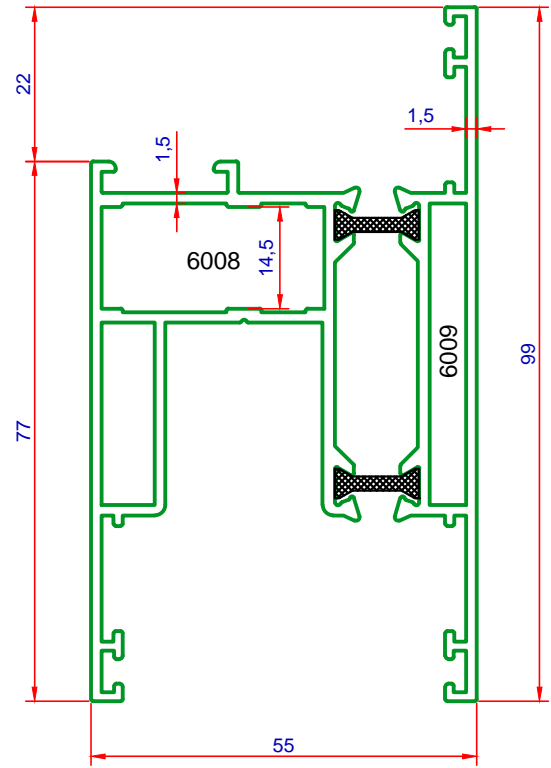

6008 - 6009
1.985 kg/m

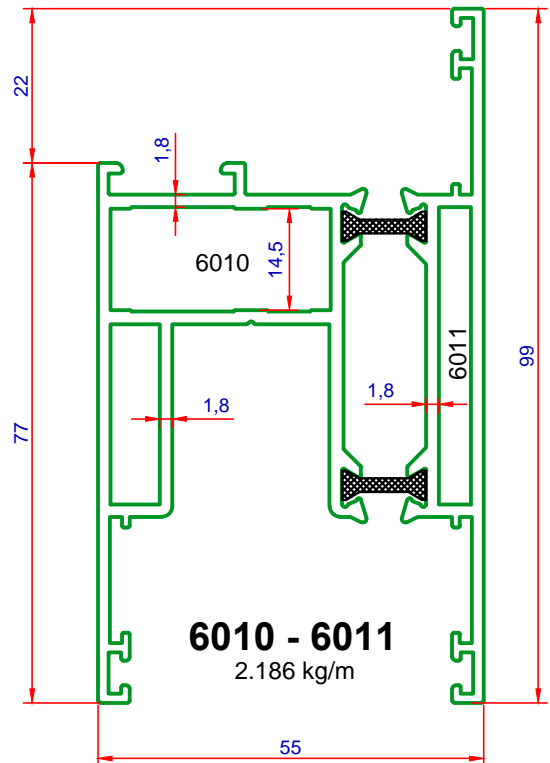

6010 - 6011
2.186 kg/m

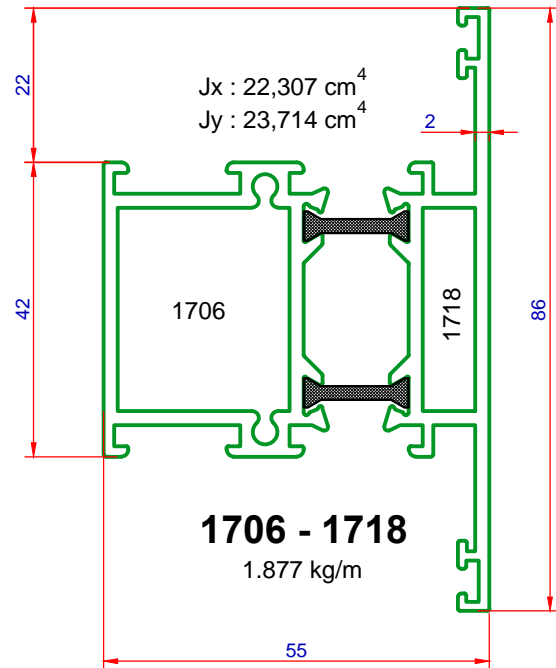
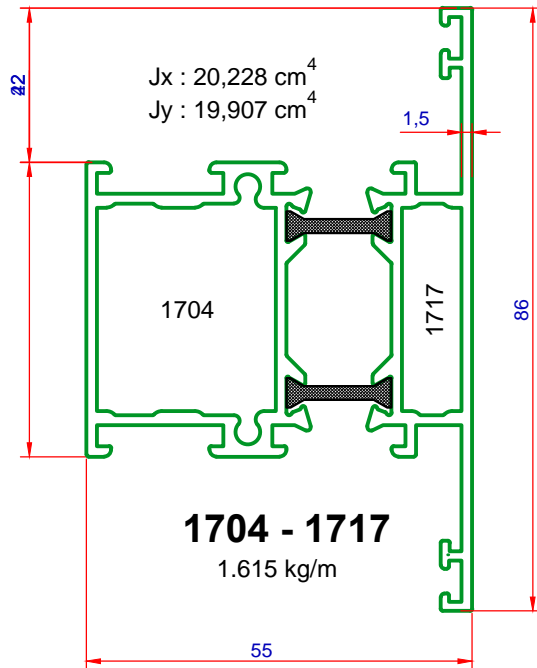
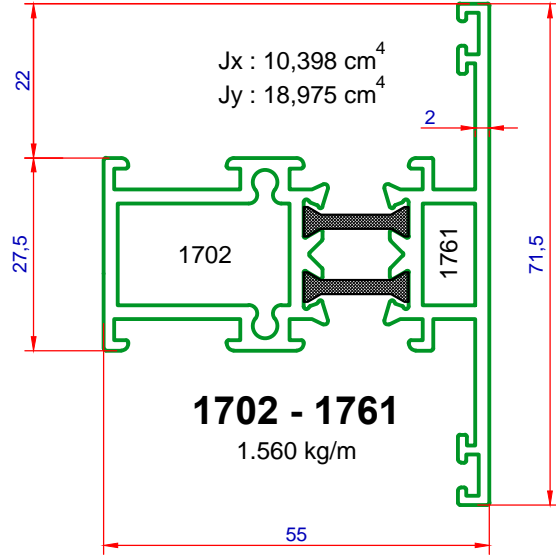
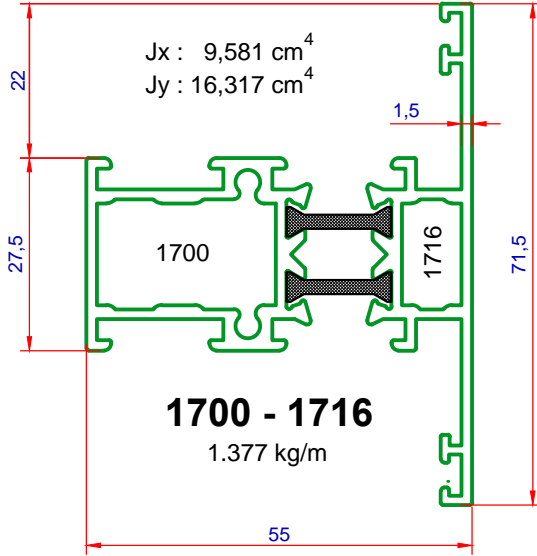

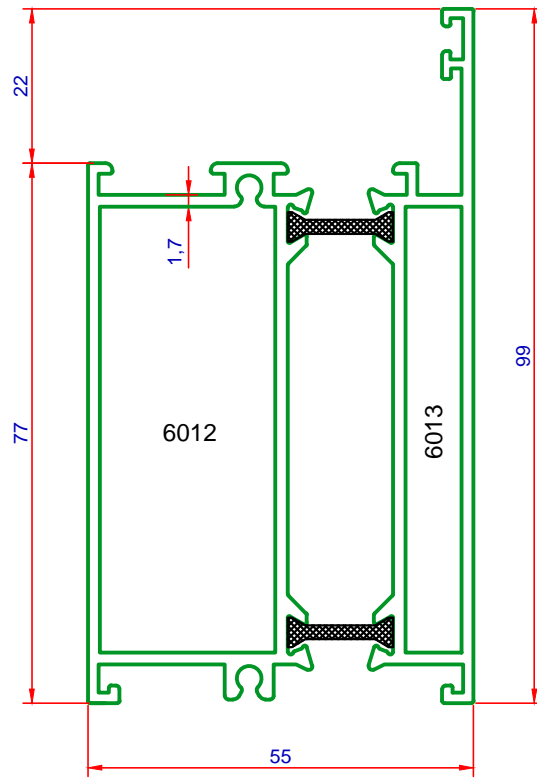

6012 - 6013
2.218 kg/m

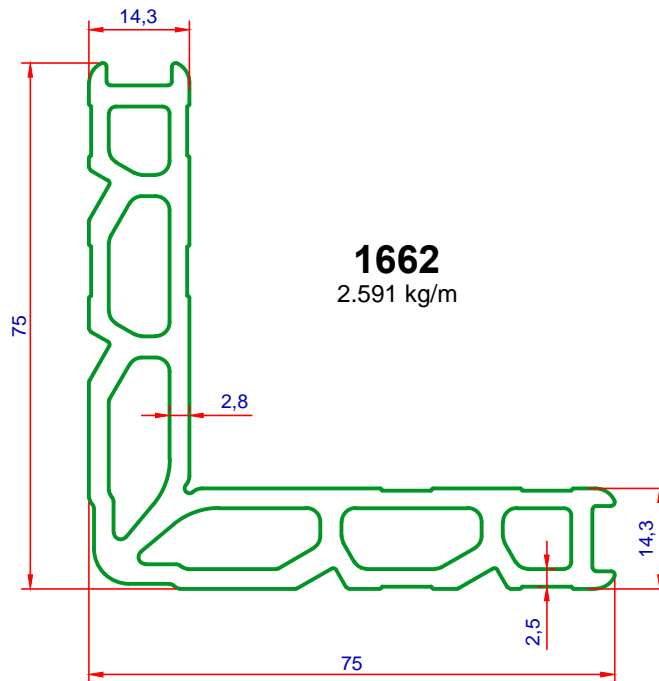

1662
2.591 kg/m

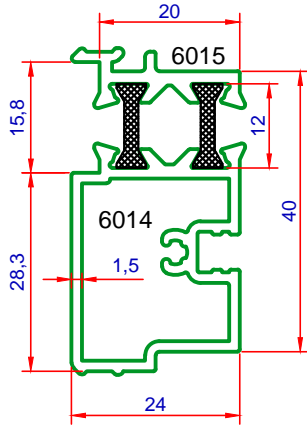

6014 - 6015
0.878 kg/m

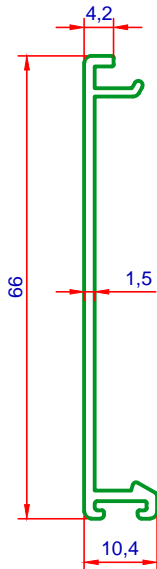
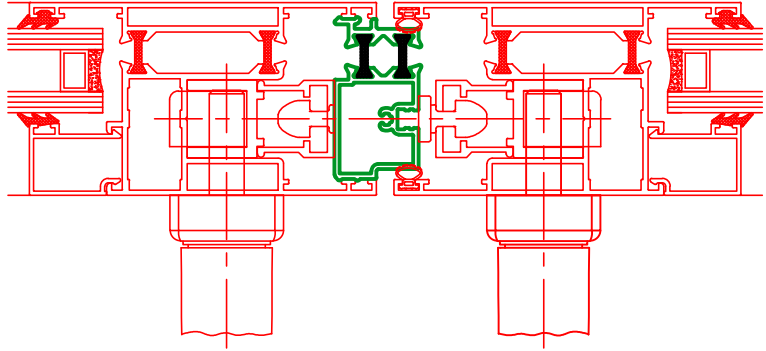

6016
0.361 kg/m

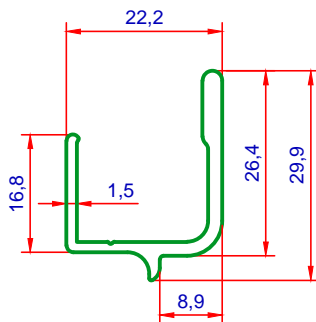
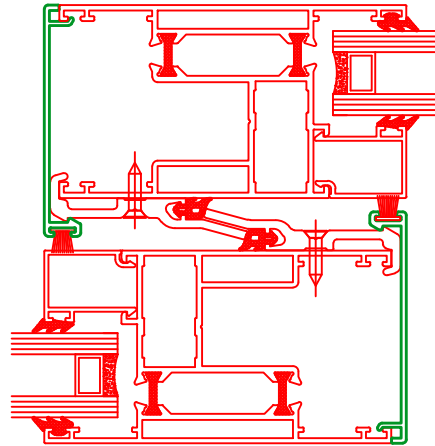

6017
0.327 kg/m

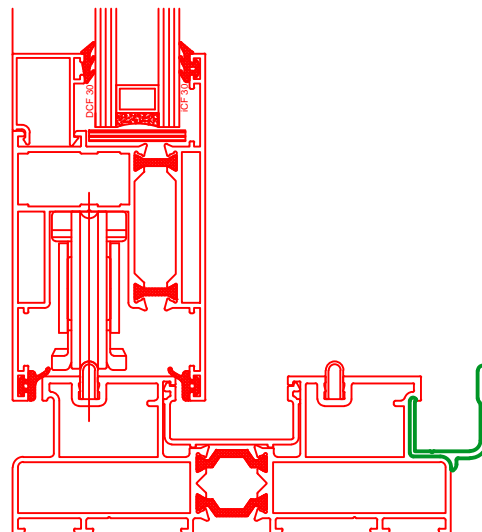

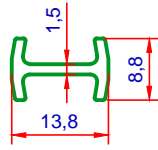

6018
0.120 kg/m

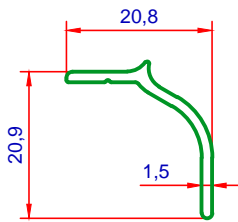

6019
0.148 kg/m

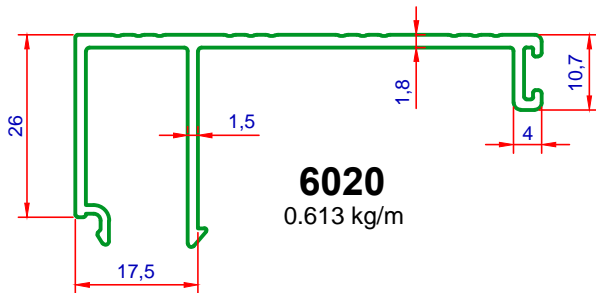

6020
0.613 kg/m

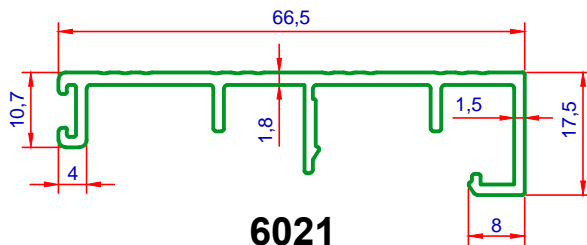

6021
0.570 kg/m

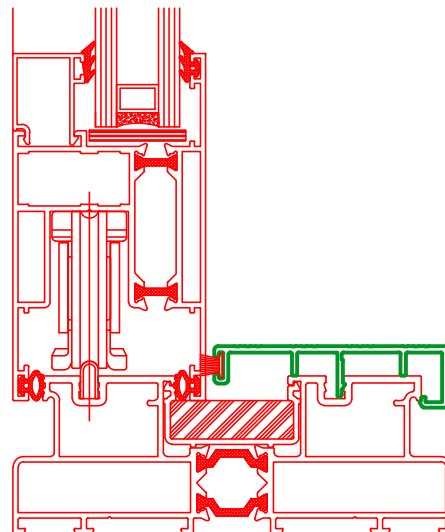
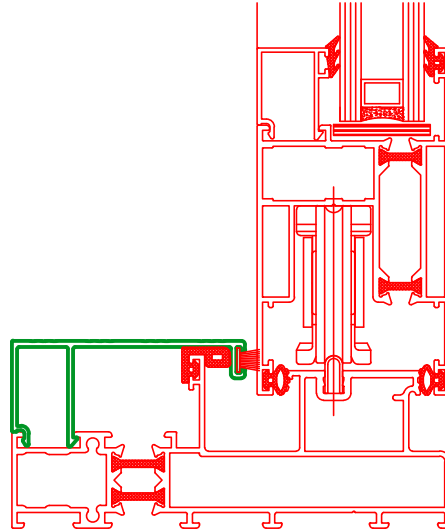
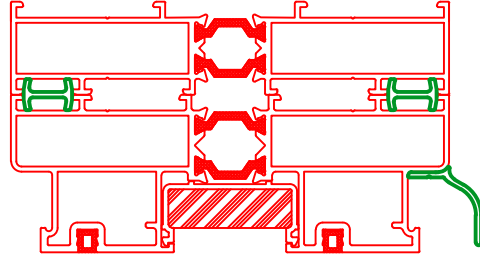

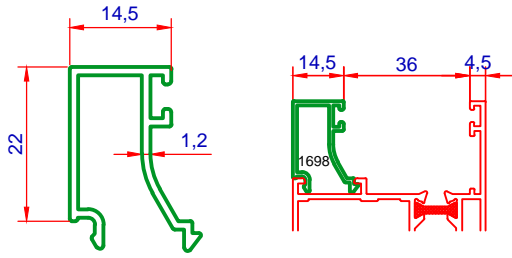

1698
0.252 kg/m

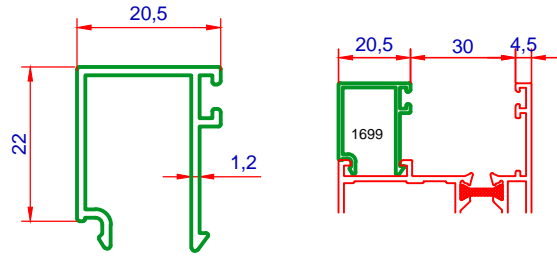

1699
0.262 kg/m

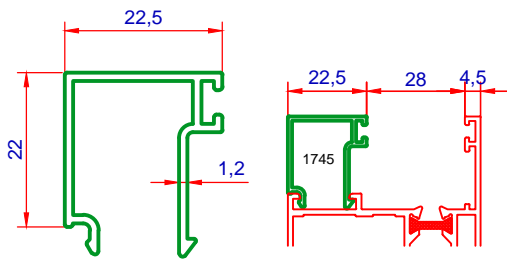

1745
0.271 kg/m

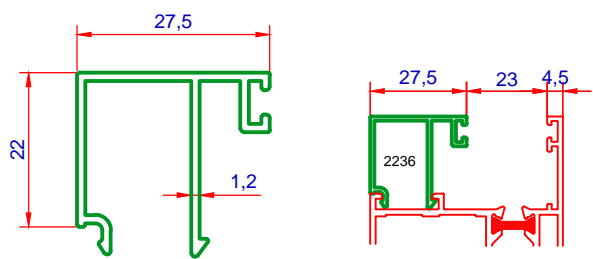

2236
0.308 kg/m

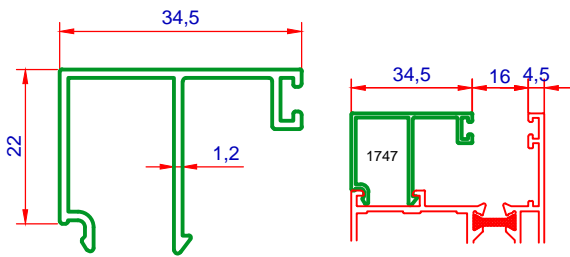

1747
0.331 kg/m

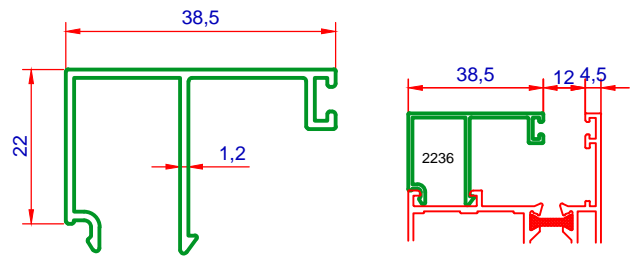

1749
0.344 kg/m

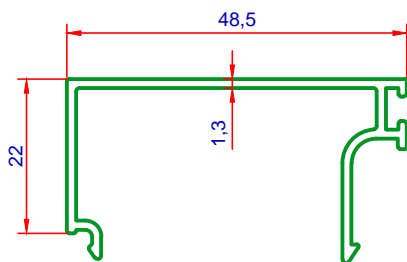

6022
0.394 kg/m

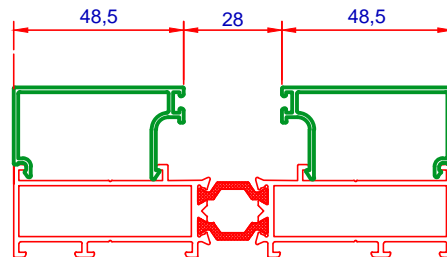

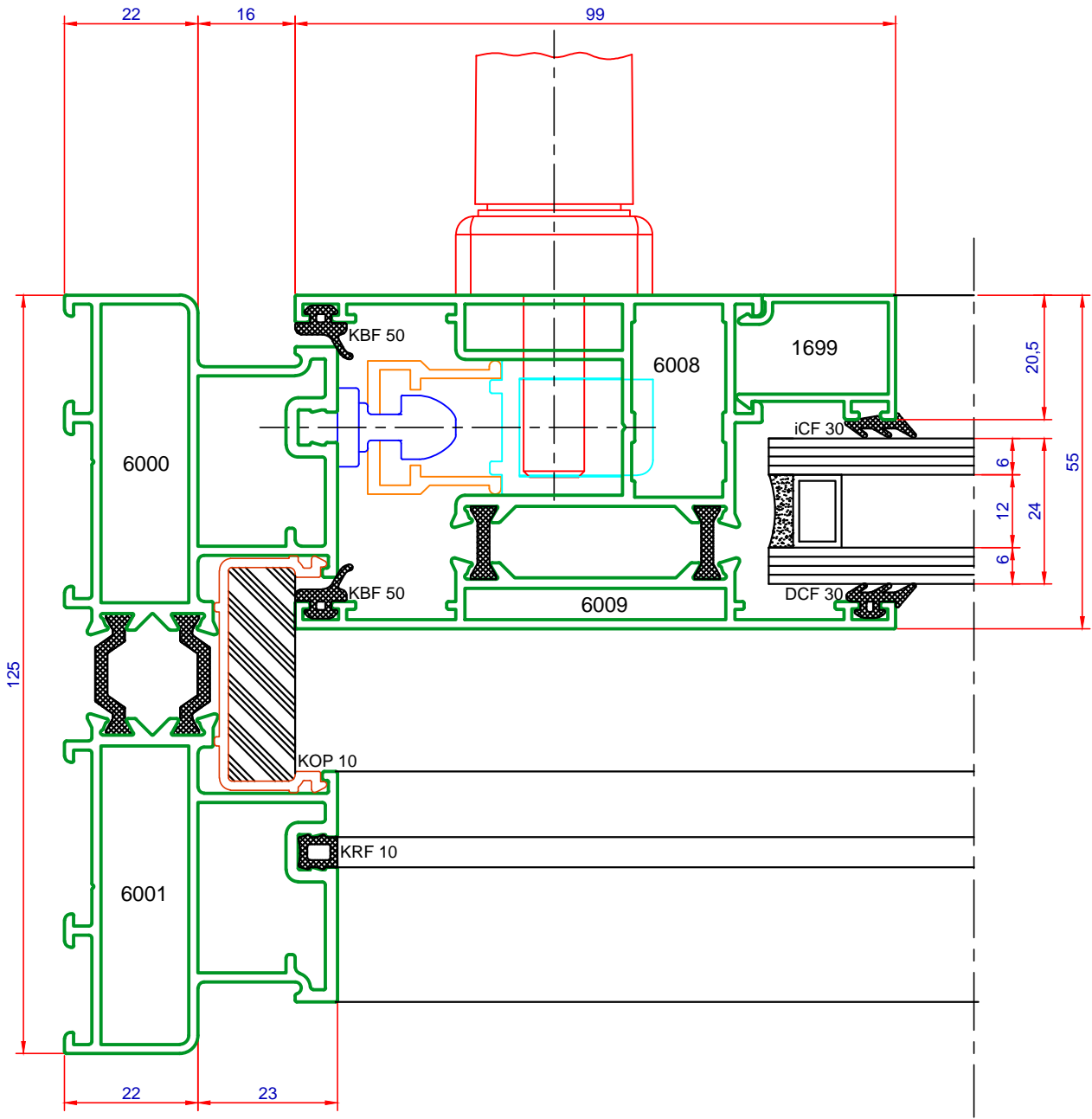
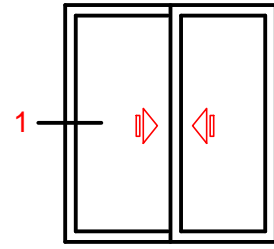

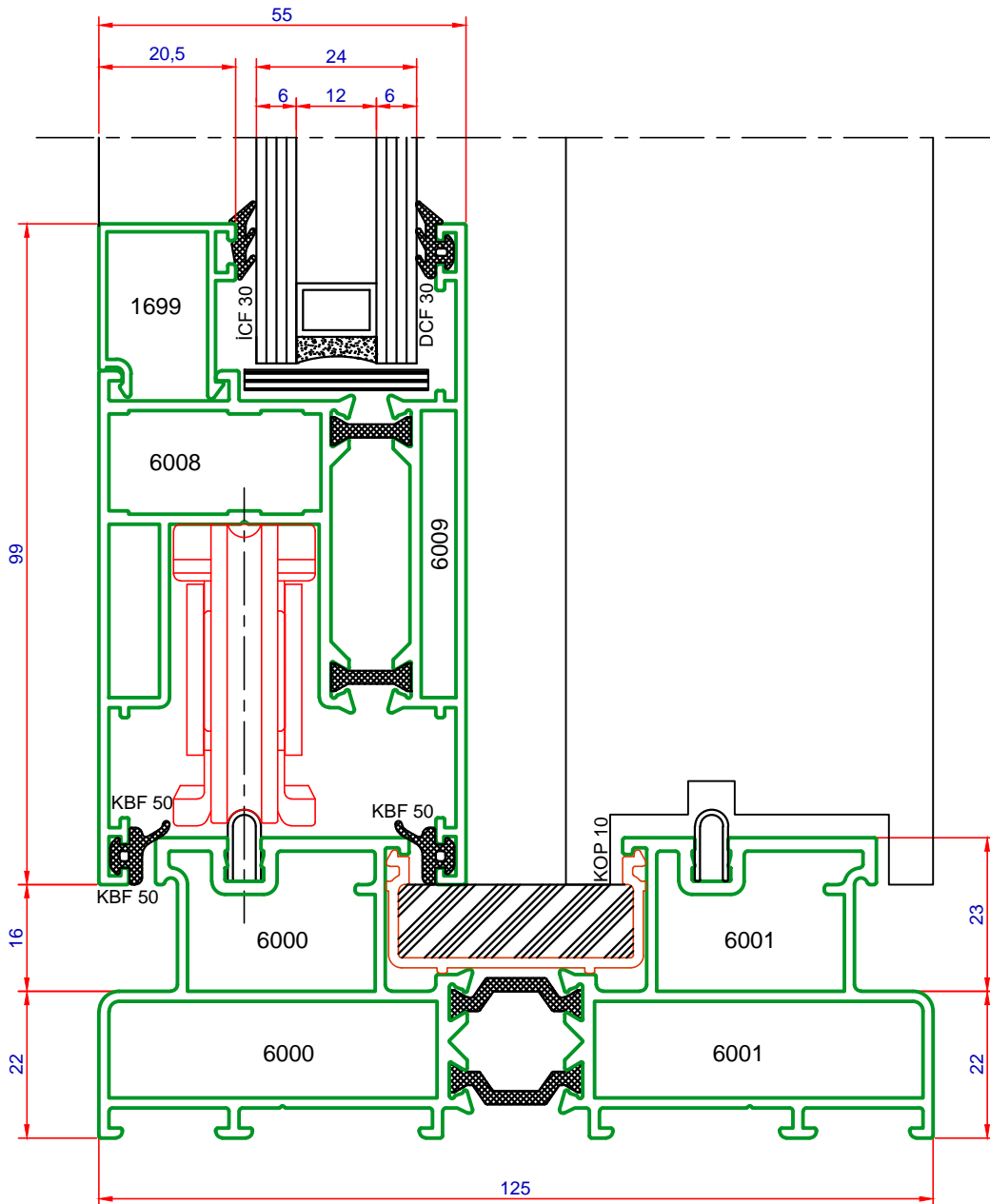
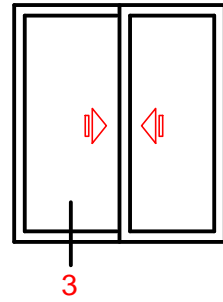

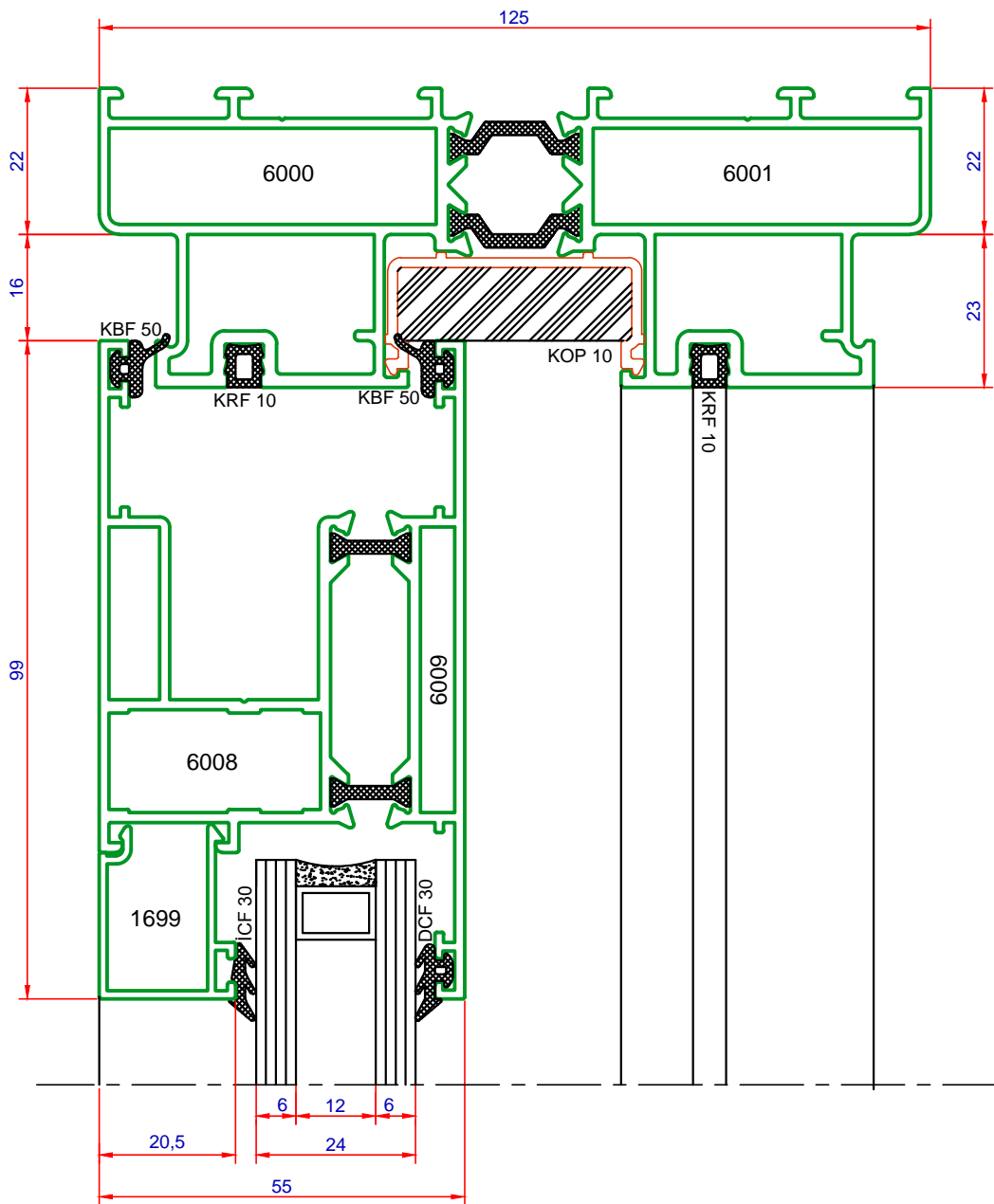
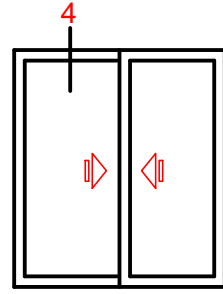

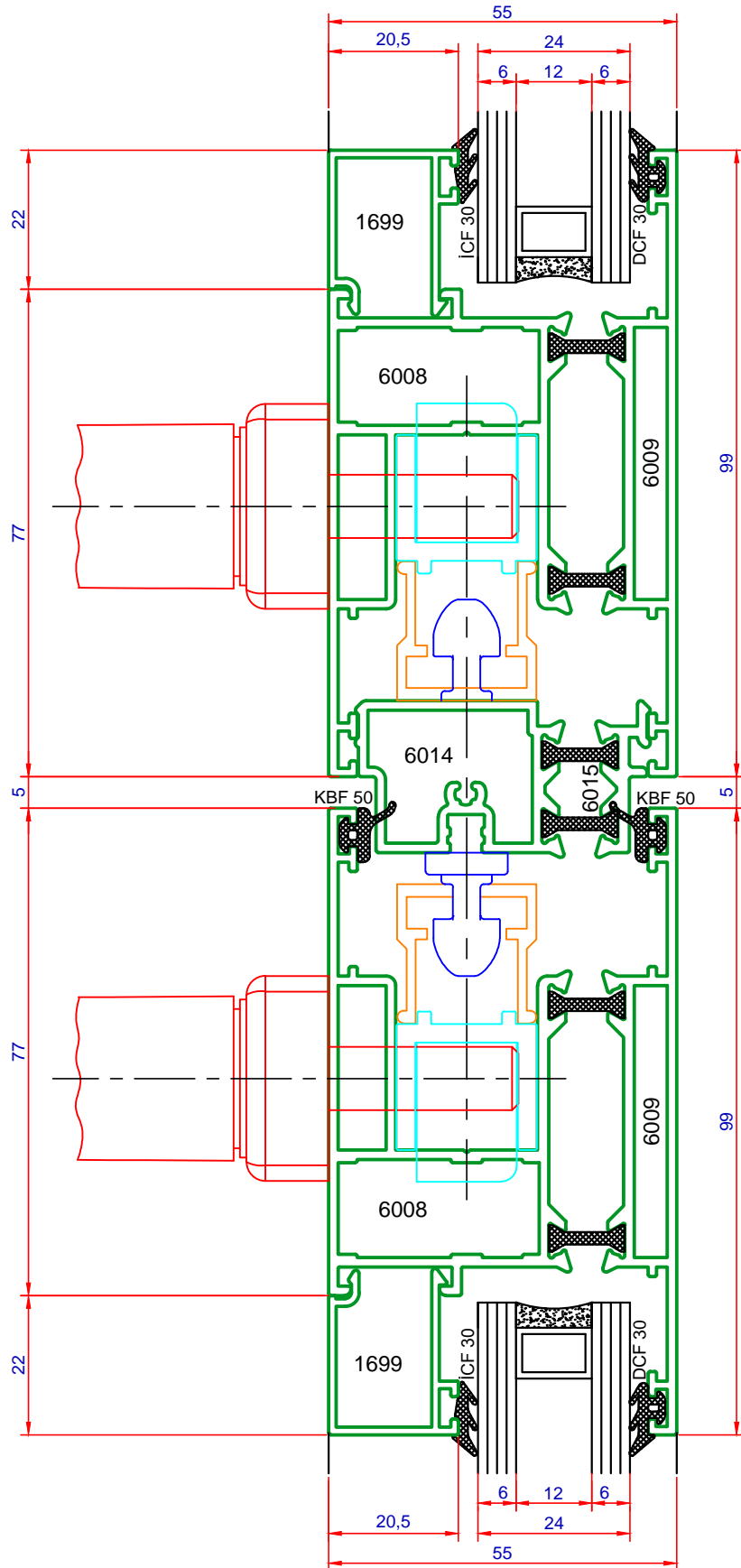
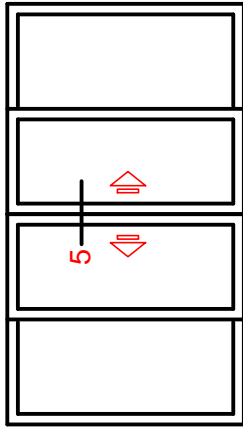

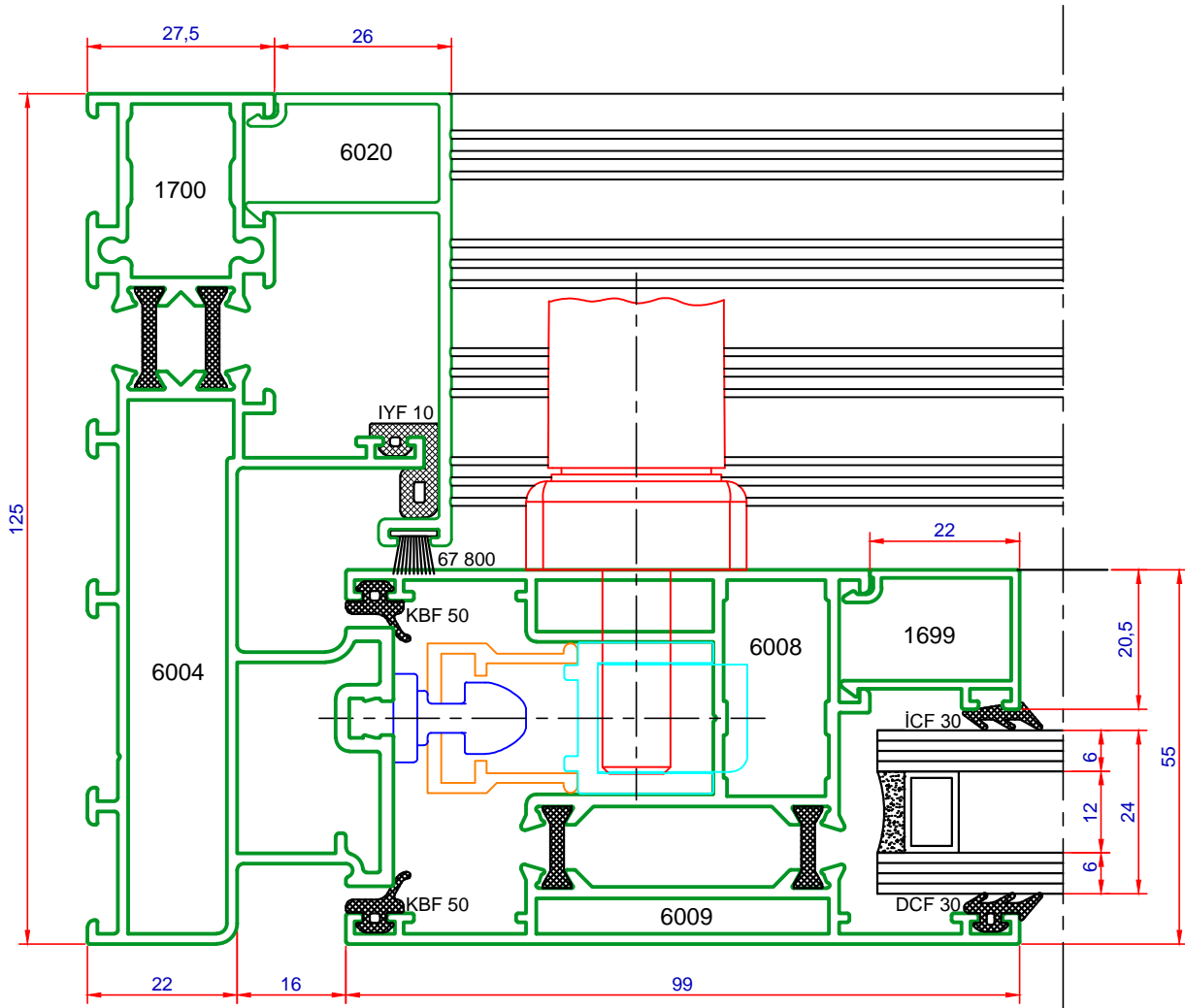
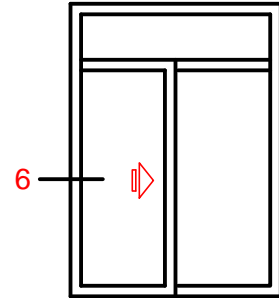

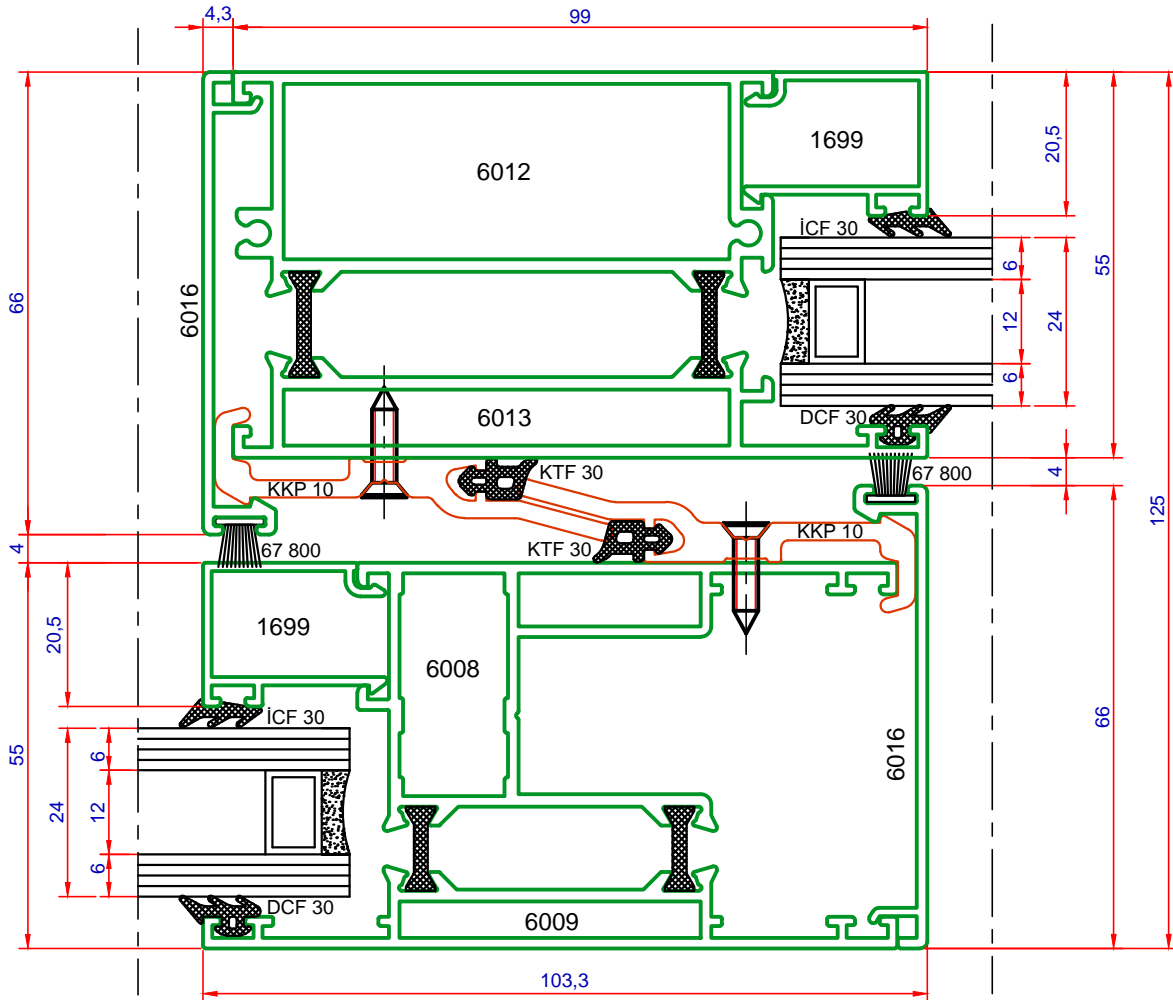
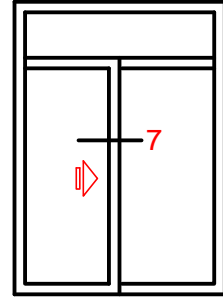

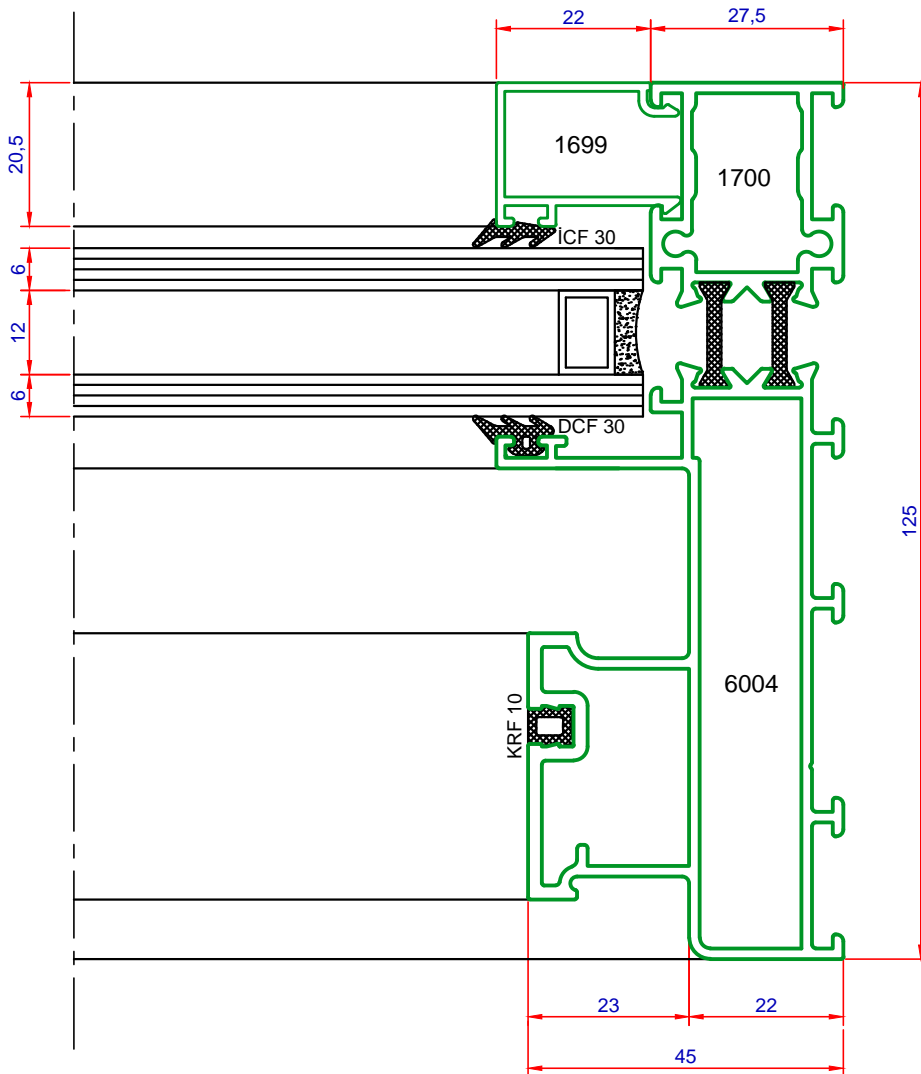
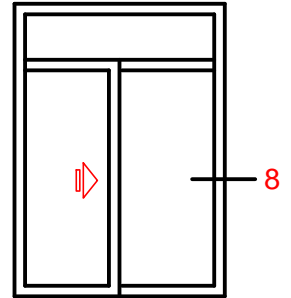

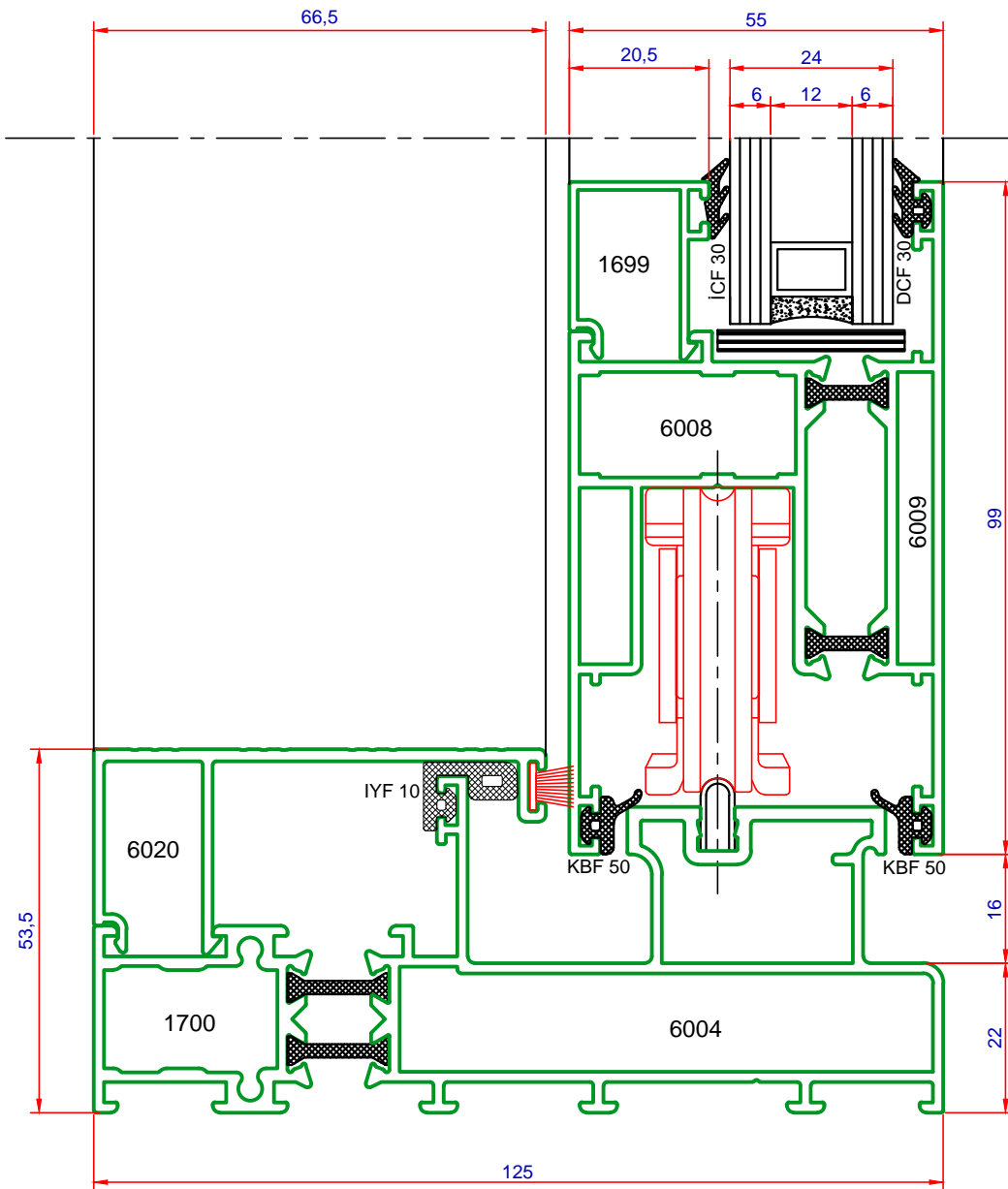
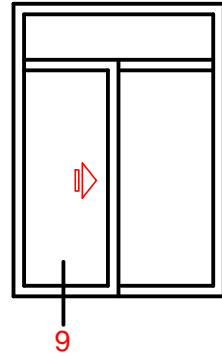

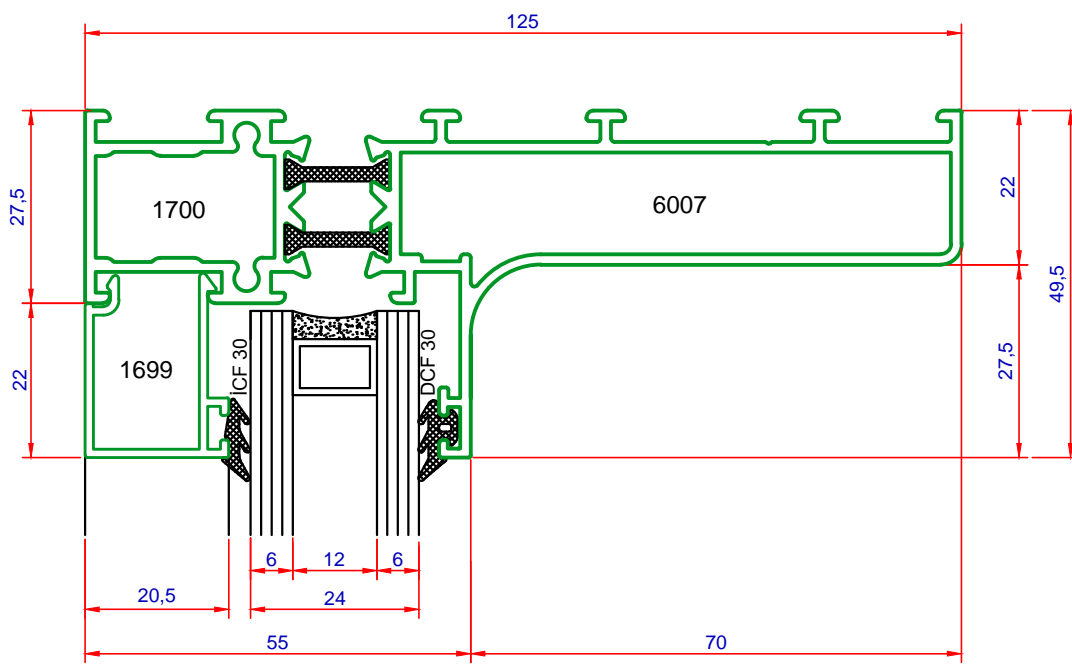
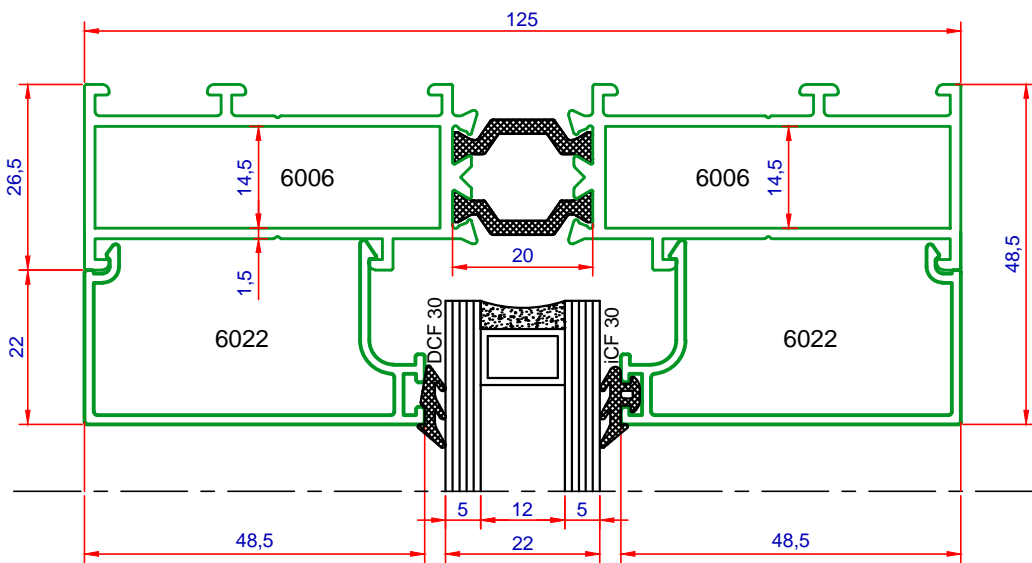
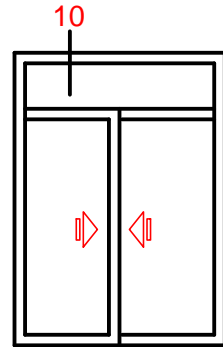

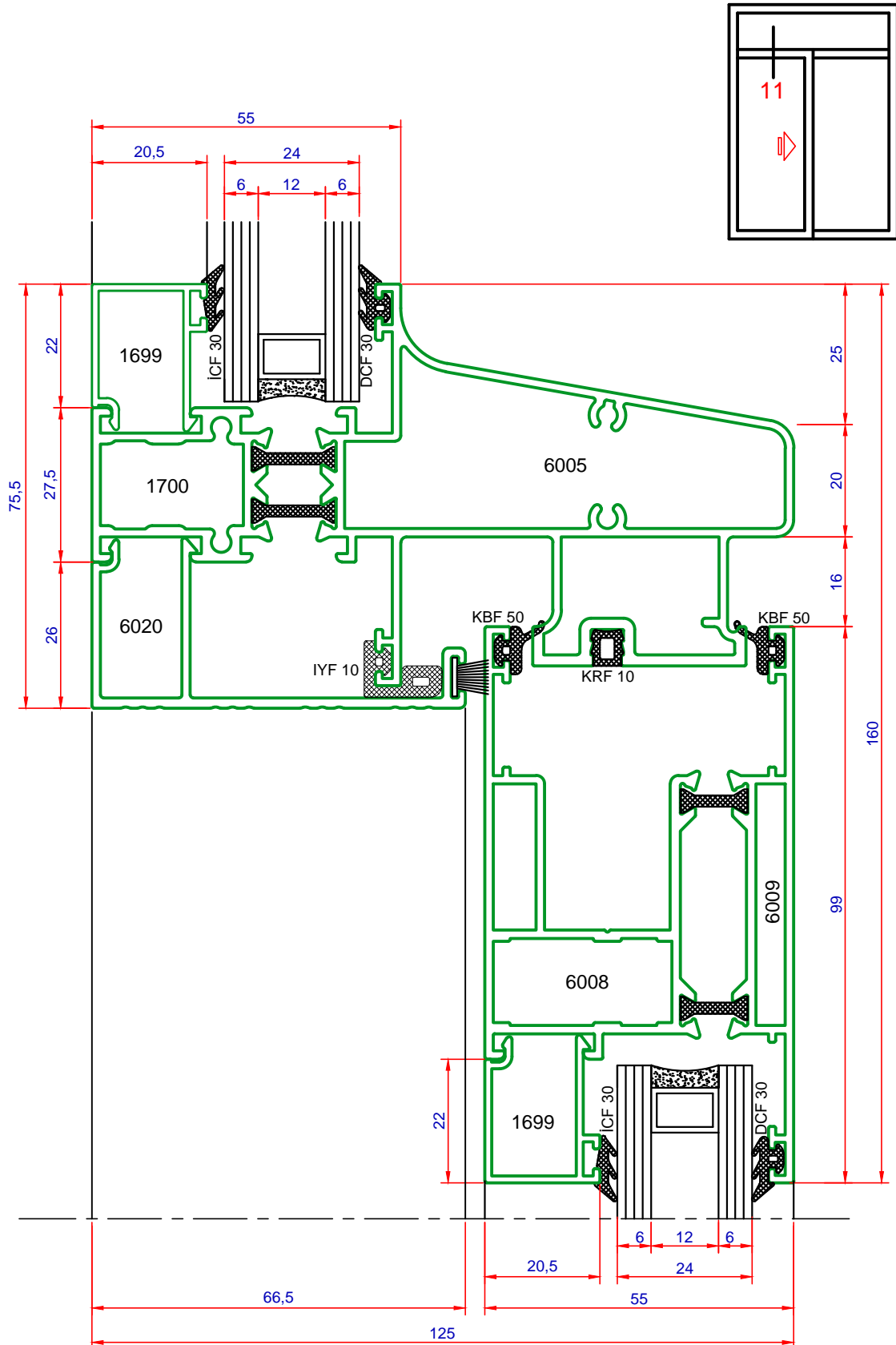

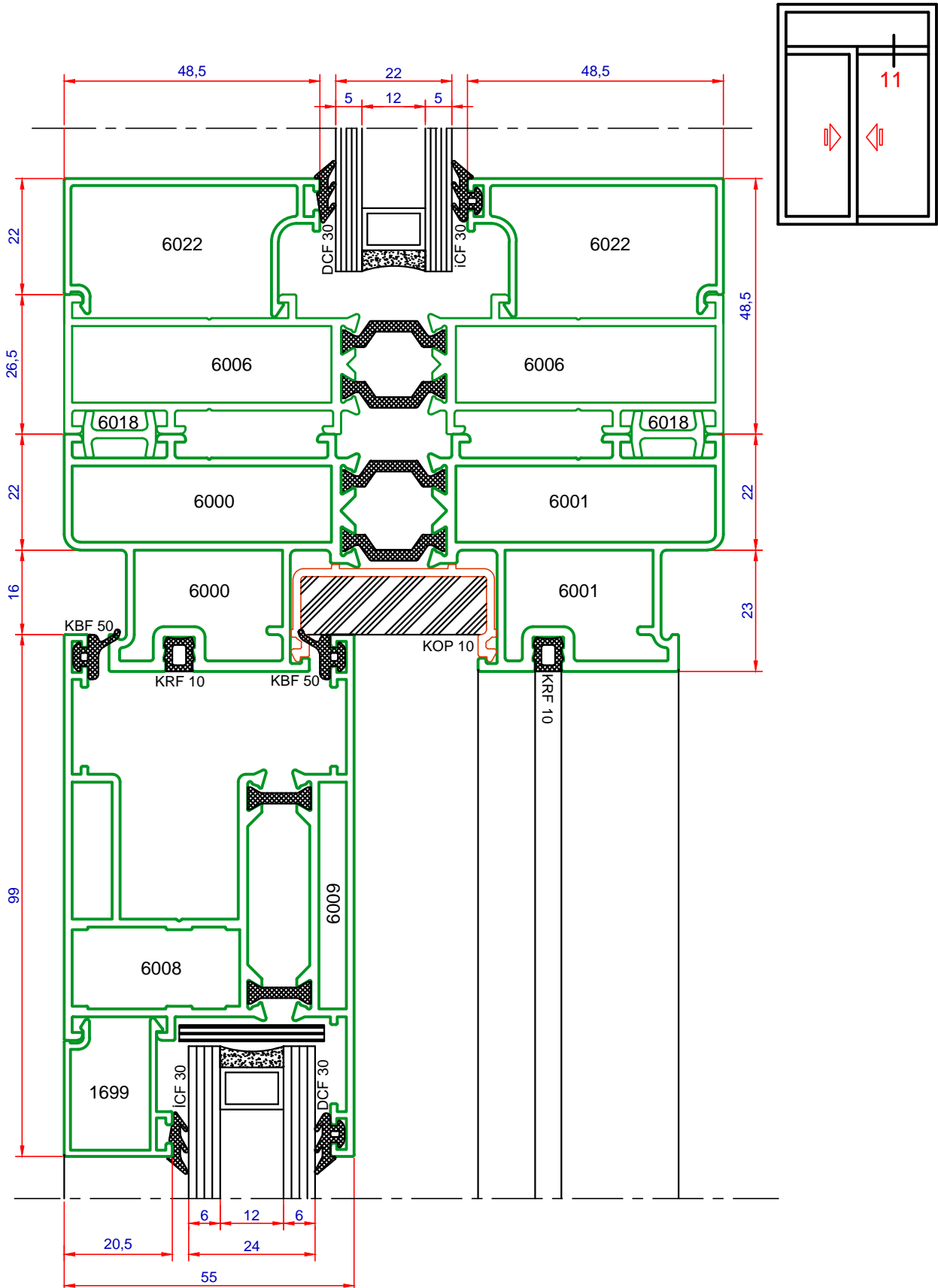

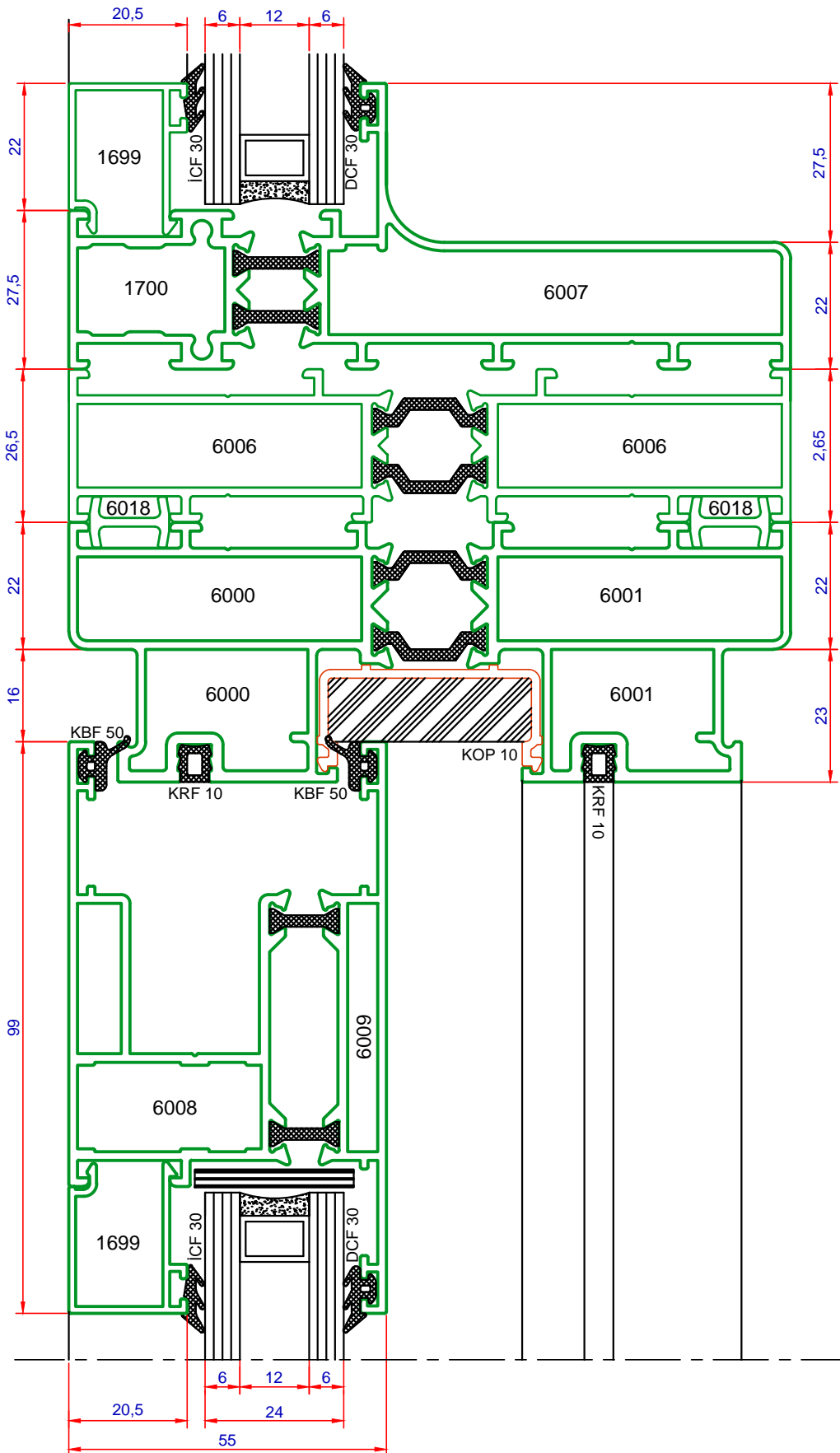

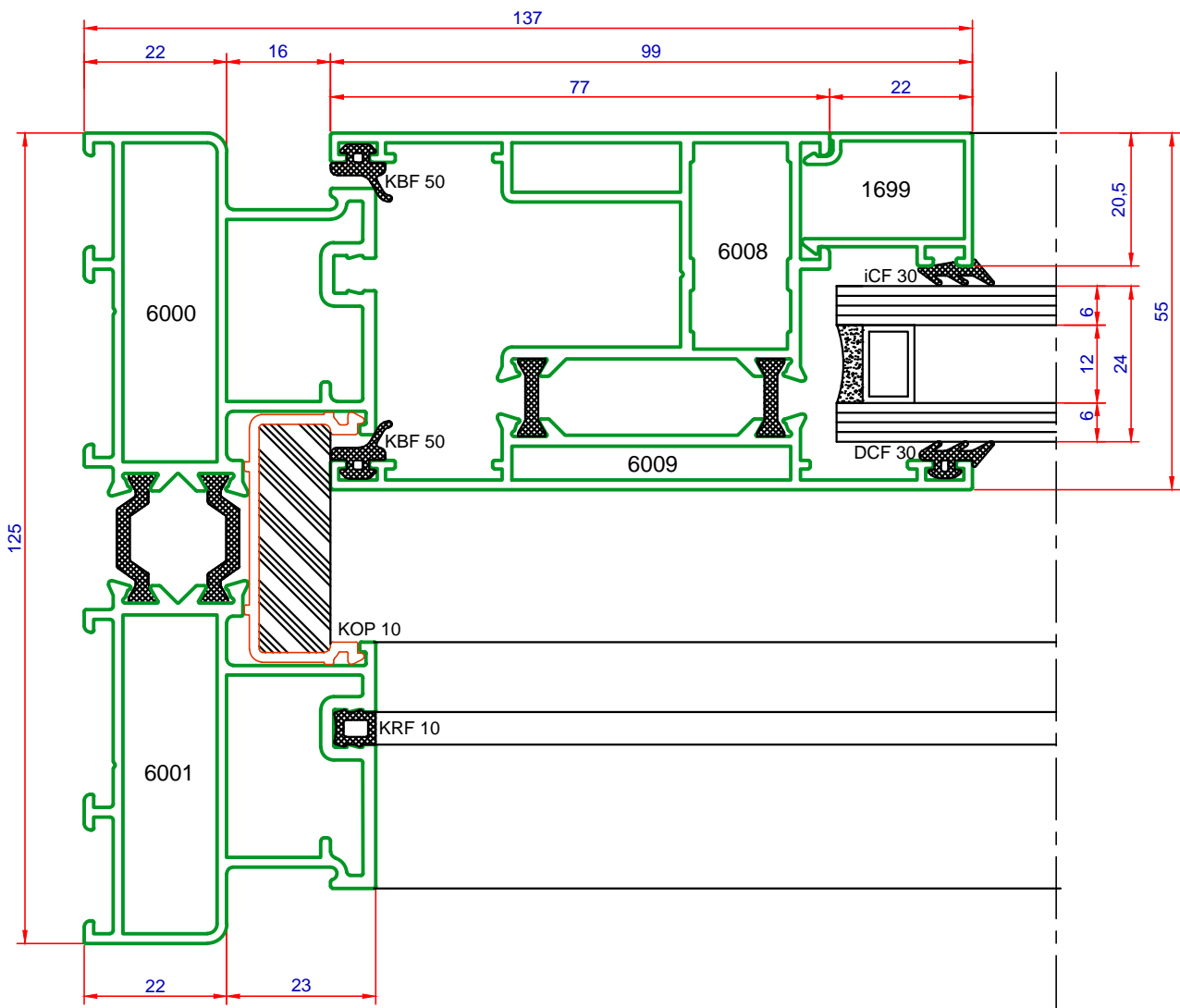
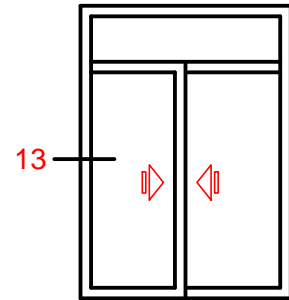

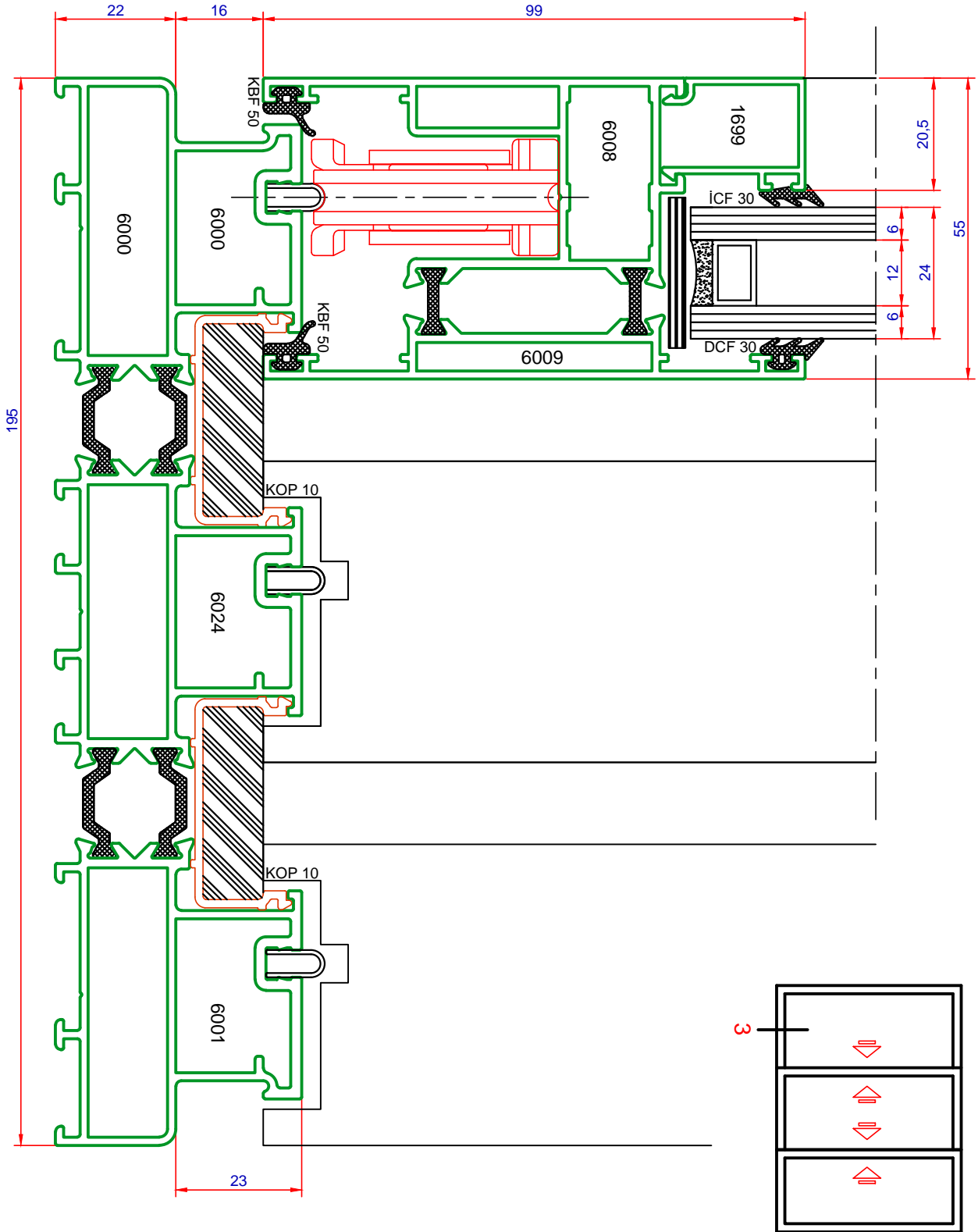









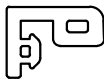

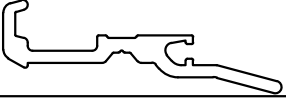

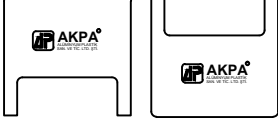

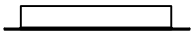
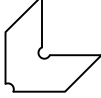
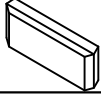
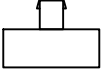
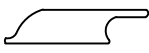
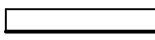
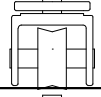
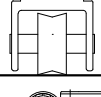
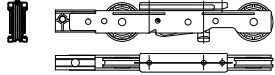
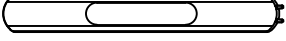

KOD NO.	ŞEKİL	ADI	MALZEME KOLİ/ADET
03 010503		DCF 30 Dış Cam Fitili 3 mm	EPDM 1pk.320 Metre/15kg.
03 011230		İCF 30 İç Cam Fitili 3 mm	EPDM 1pk.415 Metre/15kg.
03 011231		İCF 40 İç Cam Fitili 4 mm	EPDM 1pk.360 Metre/15kg.
03 010732		İCF 50 İç Cam Fitili 5 mm	EPDM 1pk.280 Metre/15kg.
03 010620		KBF 50 Kulak Bini Fitili	EPDM 1pk.400 Metre/15kg.
03 010800		KRF 10 Kasa Raptiye Fitili	EPDM 1pk.500 Metre/15kg.
03 010444		KTF 30 Kenet Süspansiyon Fitili	EPDM 1pk.330 Metre/15kg.
03 010801		İYF 10 Isı Yalıtım Fitili	EPDM 1pk.160 Metre/15kg.
03 050409		Tozluk Fitili 67-800	1pk.250 Metre
03 050413		Tozluk Fitili 67-1000	1pk.250 Metre
01 300100		Kanat Kenet Plastiği KKP 10	PVC 1boy 6 metre
01 300101		Kasa Oluk Plastiği KOP 10	PVC 1boy 6 metre
01 300102		Kenet Alt ve Üst Kapağı	PVC 1 pk./4 Adet
04 010200		Paslanmaz Ray	ÇELİK 1boy 6 metre

KOD NO.	ŞEKİL	ADI	MALZEME KOLİ/ADET
01 300103		Sızdırmazlık Üst Sünger	Adet
01 300104		Kanat Köşe Çavuşu	ÇELİK (Paslanmaz)
04 010111		Su Tahliye Tapası	PVC 1pk.1000 Adet
01 300106		Stoper	PVC 1 pk./100 Adet
01 300107		Seviye Ayarlama Parçası Spacer	PVC 1 pk./100 Adet
01 300108		Sızdırmazlık Alt Sünger	1 pk./10 Adet
01 300150		Tekli Normal Sürme Rulman	Adet
01 300151		Çiftli Normal Sürme Rulman	Adet
01 300200		Kaldır Sür Aks.Takım (300 kg.)	Takım
05 010900		Gömme Kilit Beyaz	Adet
05 010901		Gömme Kilit Gri	Adet
05 010902		Gömme Kilit Kahverengi	Adet
05 010903		Gömme Kilit Siyah	Adet
05 300105			Kanat Durdurma Takozu Stoper